

MẶT BẰNG CĂN HỘ PENTHOUSE 46

(PH 01)

THE CENTRAL 3

TIM TƯỜNG: 198.2M²

THÔNG THỦY: 188.6M²

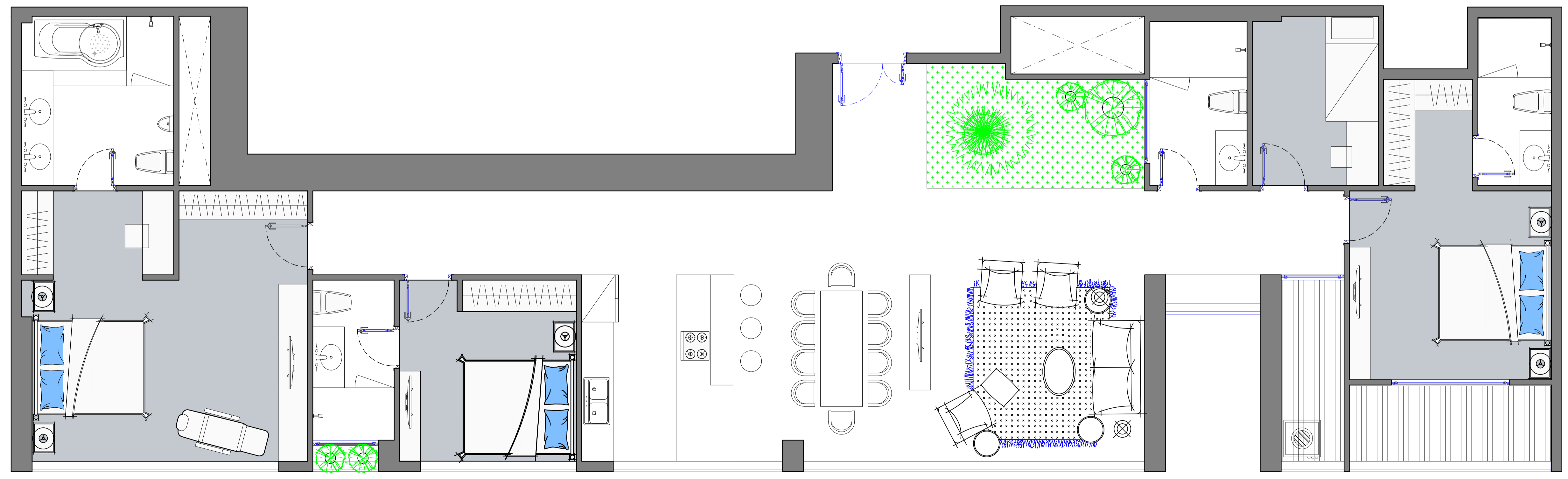
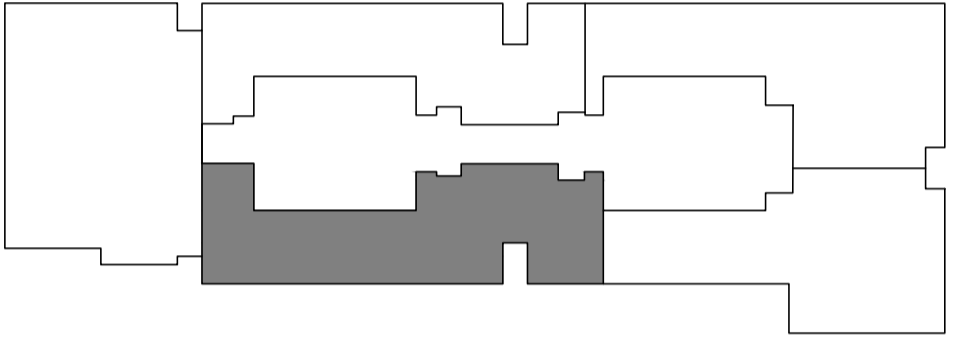
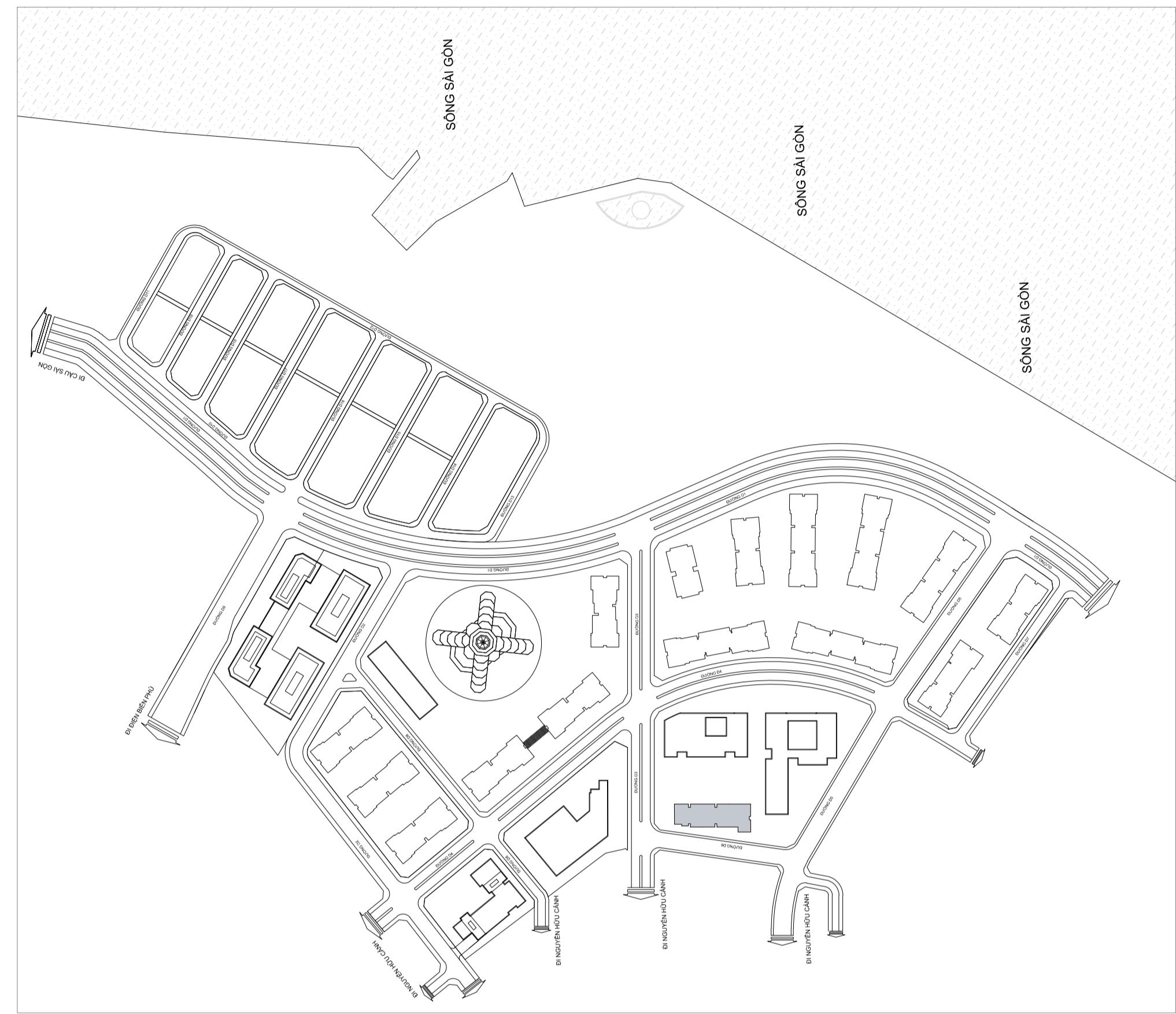
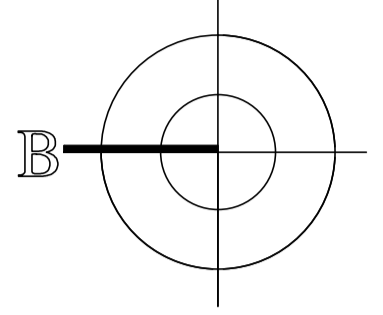

MẶT BẰNG CĂN HỘ PENTHOUSE 46 (PH 02)

THE CENTRAL 3

TIM TƯỜNG: 226.3M²
THÔNG THỦY: 220.7M²

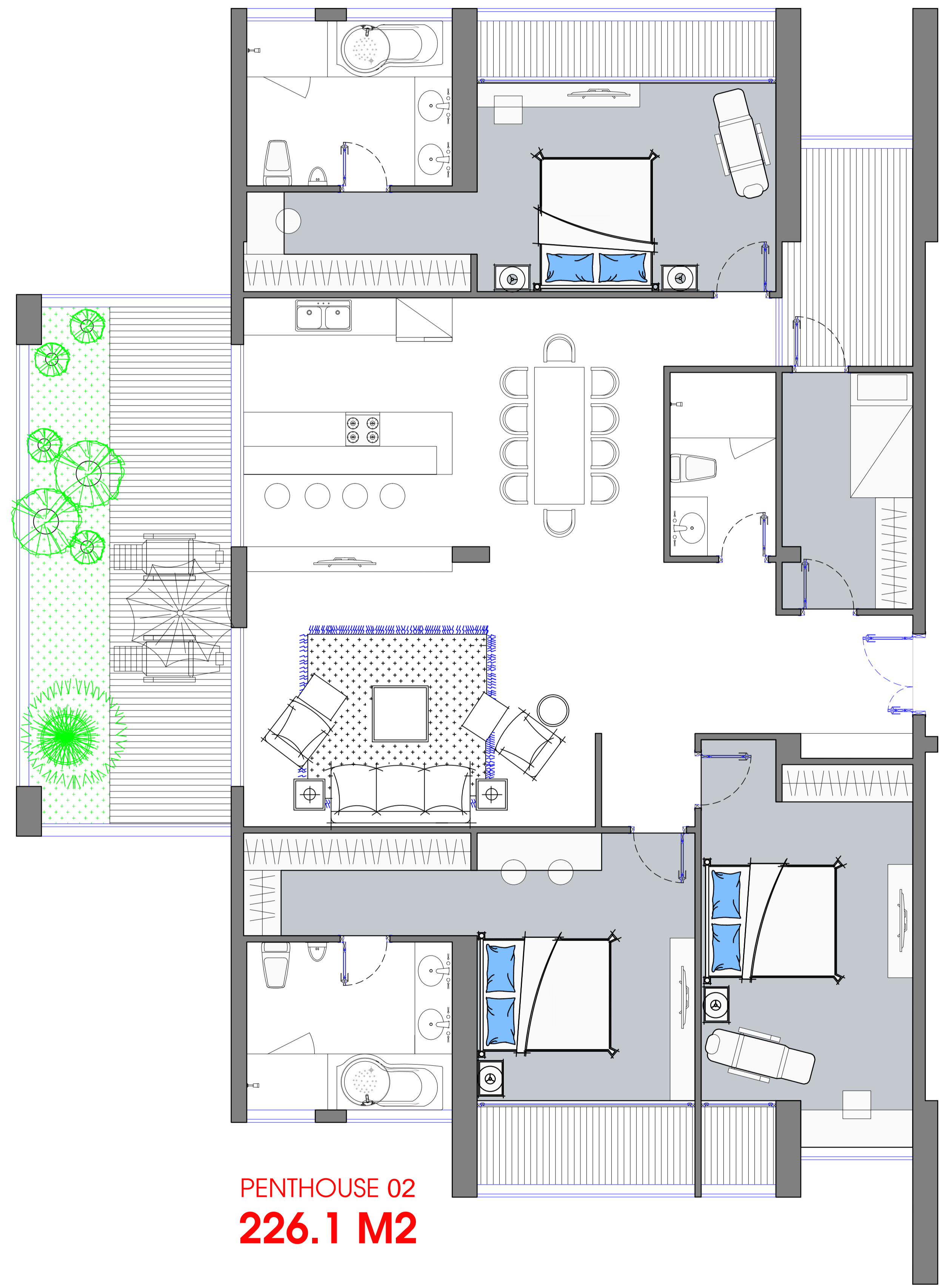
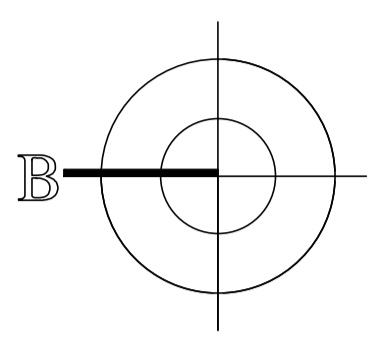

PENTHOUSE 02
226.1 M²

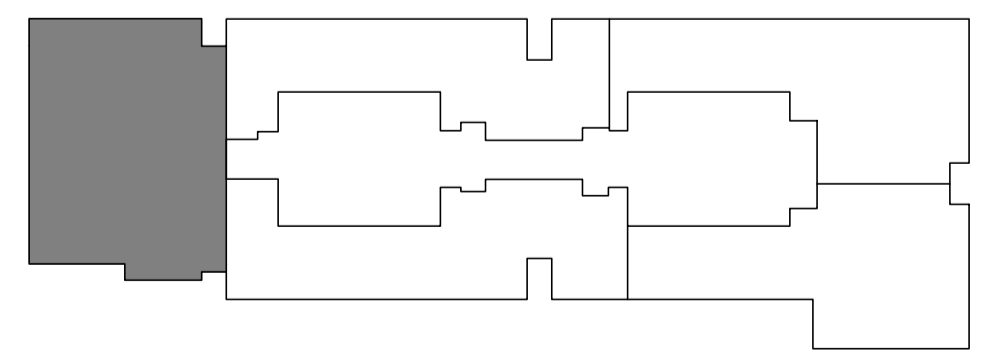
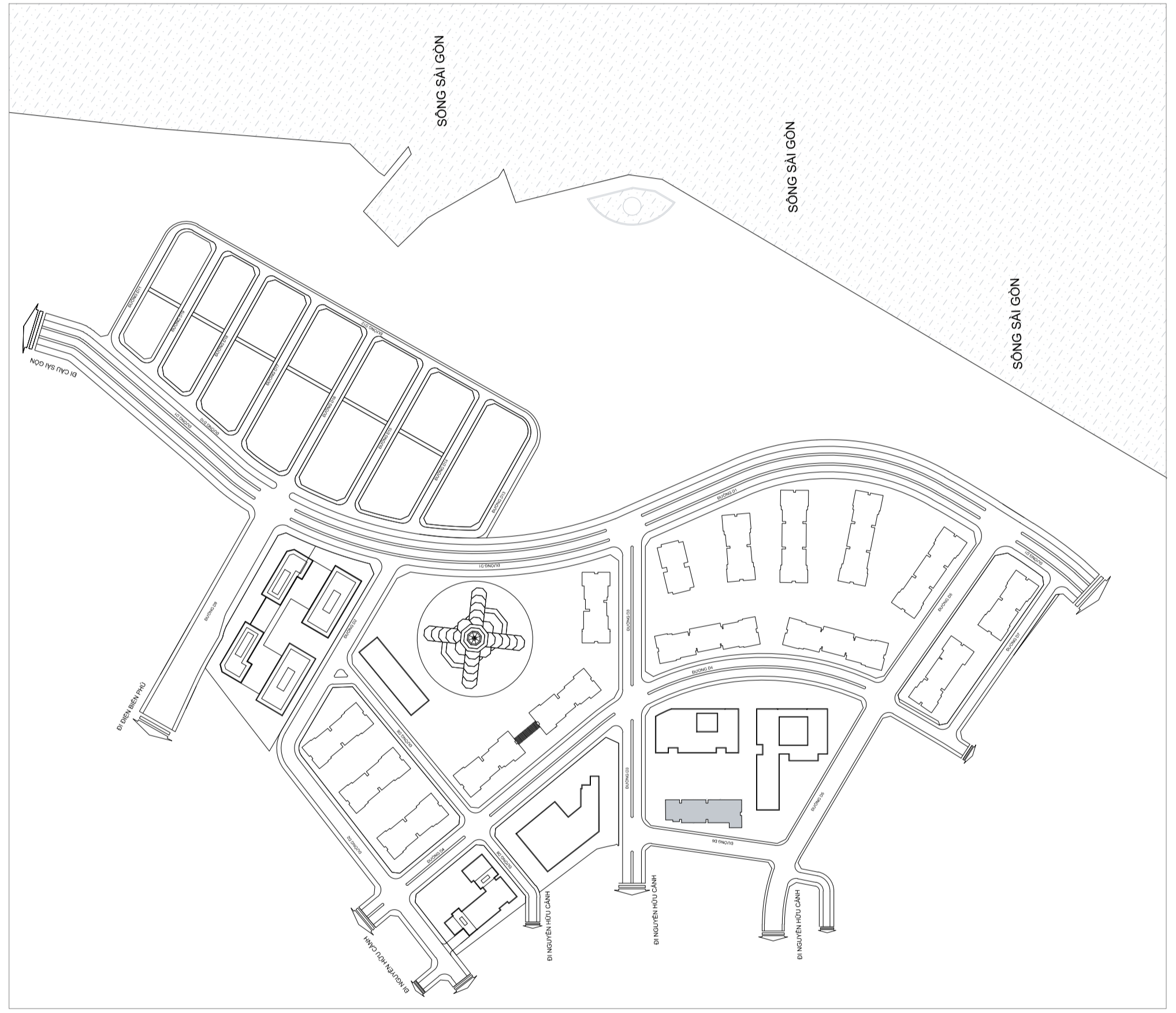

MẶT BẰNG CĂN HỘ PENTHOUSE 46

(PH 03)

THE CENTRAL 3

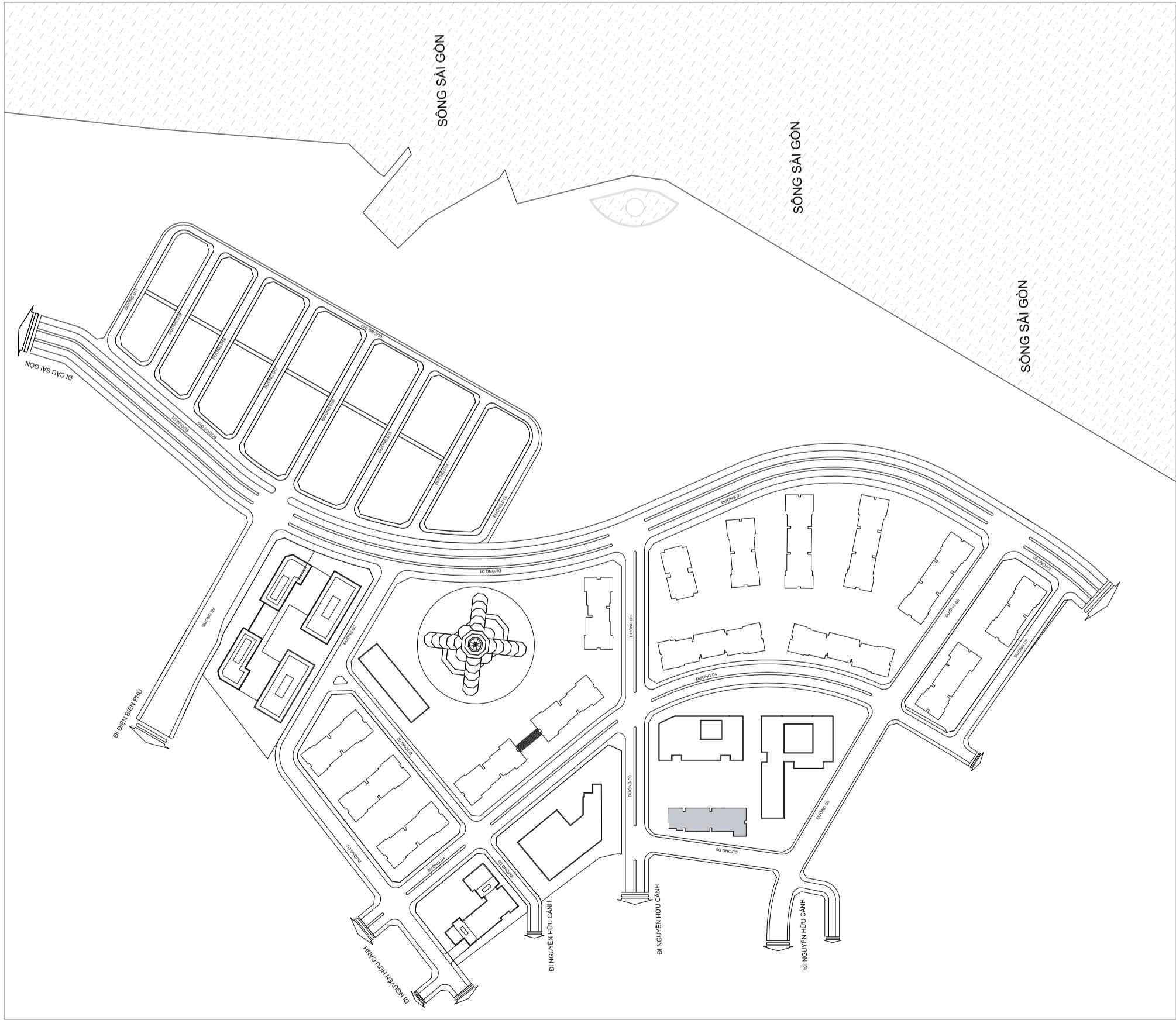
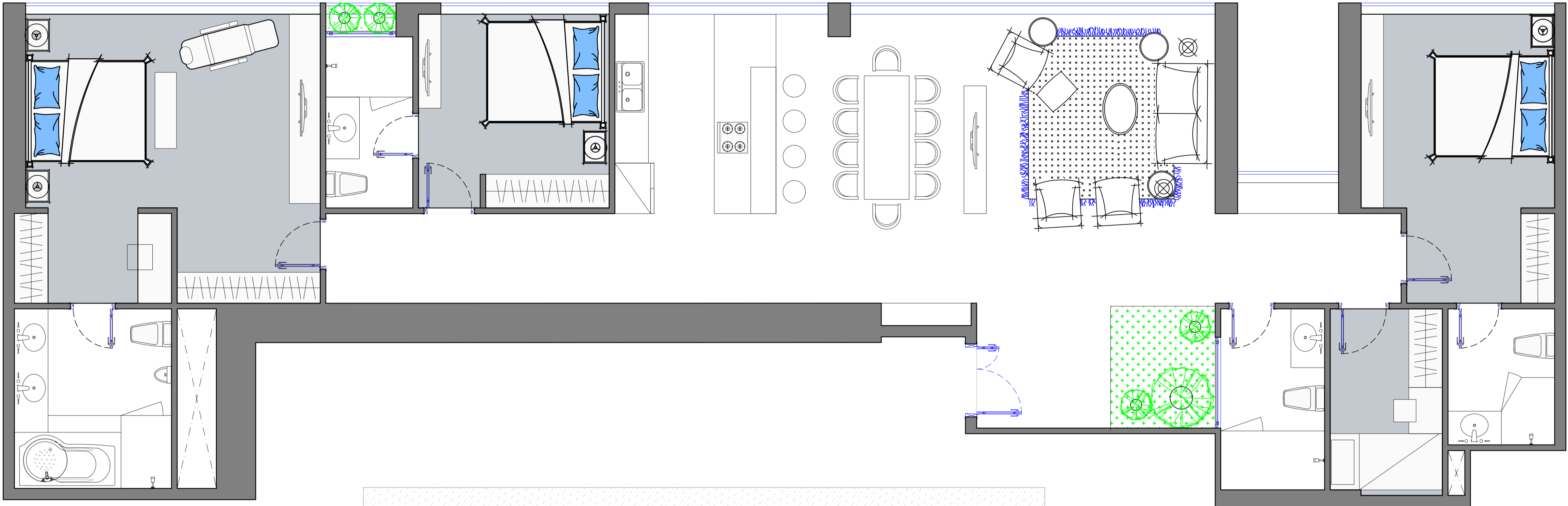
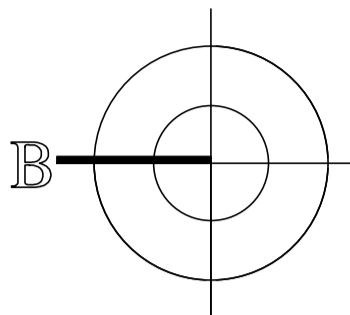

TIM TƯỜNG: 180.7M²
THÔNG THỦY: 170.6M²

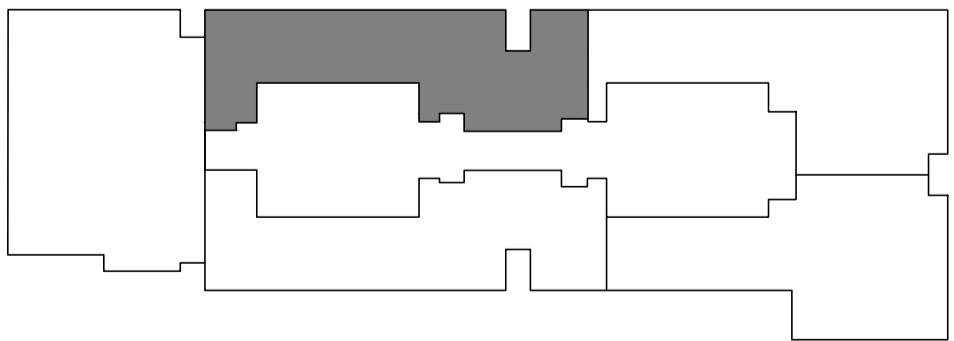

MẶT BẰNG CĂN HỘ PENTHOUSE 46

(PH 04)

THE CENTRAL 3

TỈM TƯỜNG: 205.6M²
THÔNG THỦY: 198M²

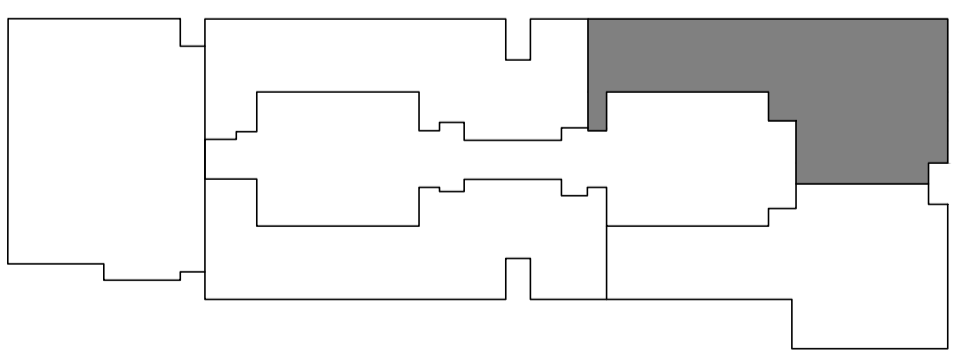
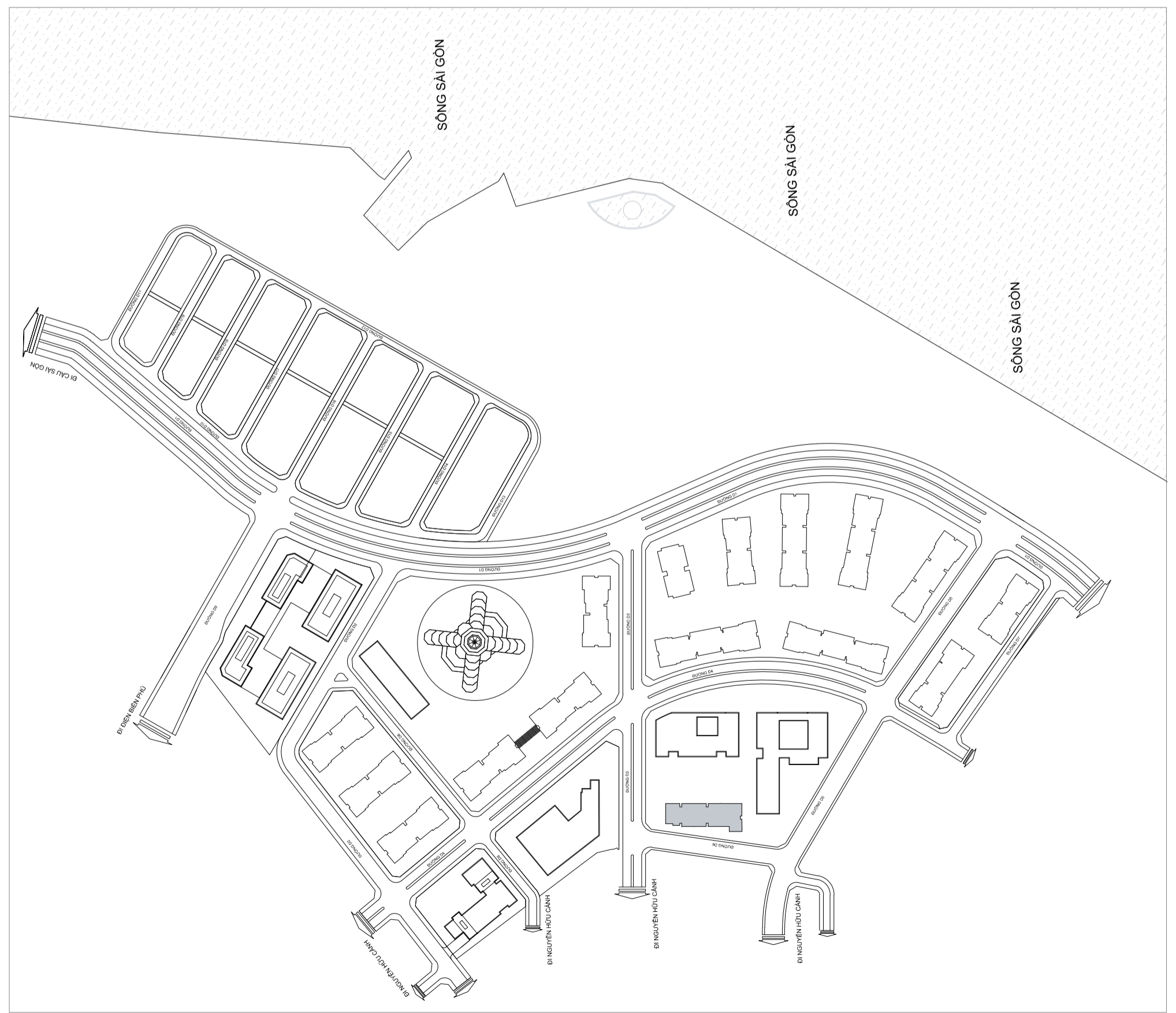
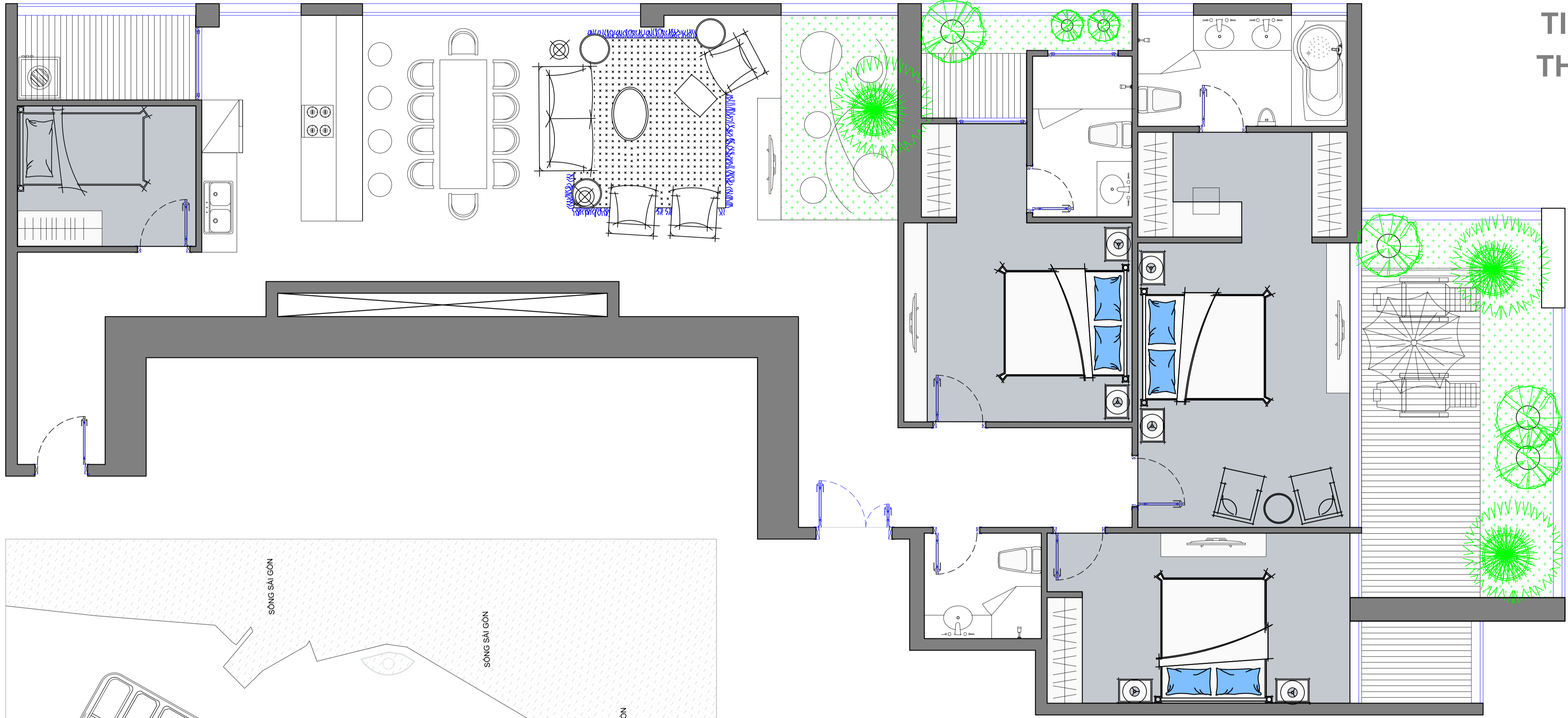
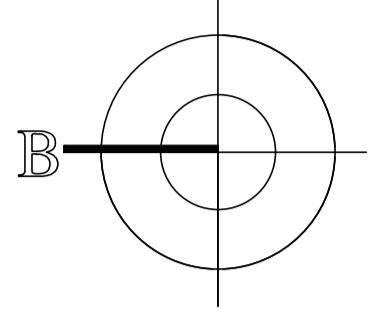

MẶT BẰNG CĂN HỘ PENTHOUSE 46 (PH 05)

THE CENTRAL 3

TIM TƯỜNG: 193.7M²
THÔNG THỦY: 186.7M²

